

THE BLOCKSHOP
New Zealand Ltd

QUALITY MASONRY SOLUTIONS

KERB STONE BLOCKS

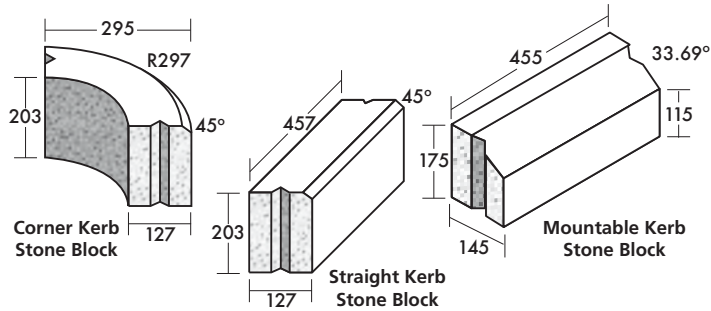

GRASS PAVERS

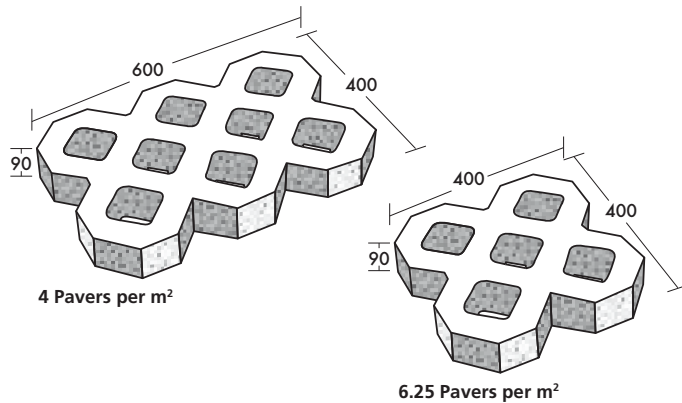

PHONE 0800 825 625
WEBSITE WWW.BLOCKSHOP.CO.NZ

THE BLOCKSHOP
New Zealand Ltd

QUALITY MASONRY SOLUTIONS

MATERIAL ESTIMATES

1m³ of Grout should fill approximately:

Product	Blocks	m ²	
15 Series	200	16.0	
15 Series Bond Beam	180	14.4	72l/m
20 Series	150	12.0	
20 Series Bond Beam	120	9.6	48l/m
25 Series	100	8.0	
25 Series Bond Beam	80	6.4	32l/m

1 bag of trade mortar lays approximately 23 x 20 Series Blocks

MASONRY BRICKS

SIZES: 70 X 90 X 230MM
70 X 115 X 230MM AND
70 X 150 X 300MM

Yard: 51 Firth Street, Drury

Plant: 148 State Highway 27, Tirau 3484

Phone: 0800 825 625

Email: info@blockshop.co.nz

Website: www.blockshop.co.nz

THE BLOCKSHOP
New Zealand Ltd

QUALITY MASONRY SOLUTIONS

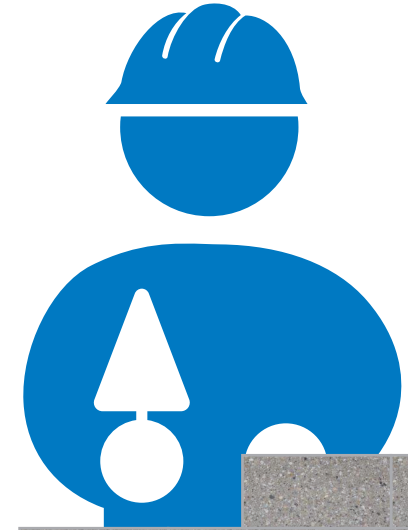

PHONE 0800 825 625
WEBSITE WWW.BLOCKSHOP.CO.NZ

10 SERIES MASONRY BLOCKS

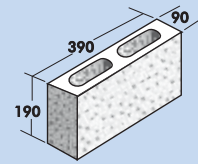

10.01
Standard Whole

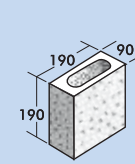

10.02
Half

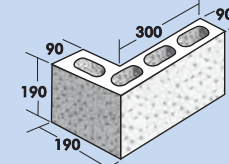

10.03
Corner

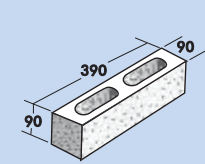

H10.01
Standard Whole

15 SERIES MASONRY BLOCKS

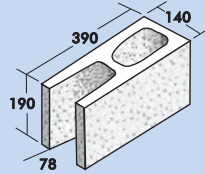

15.05
Open End

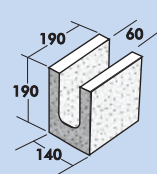

15.12
Lintel and Half-end Closer

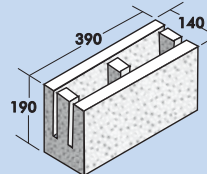

15.14
Knock-in Bond Beam

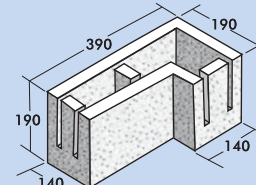

15.15
Right Hand Corner Bond Beam
(Left hand also available)

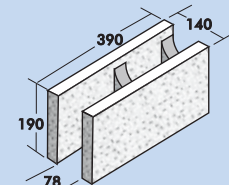

15.16
Open End Bond Beam

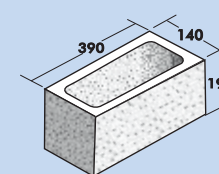

15.30
Standard 150mm Column

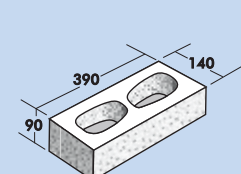

H15.04
Half High Standard

20 SERIES MASONRY BLOCKS

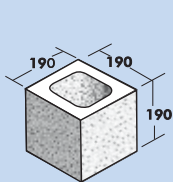

20.02
Half

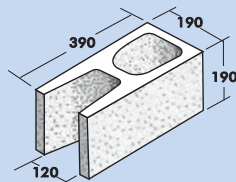

20.05
Open End

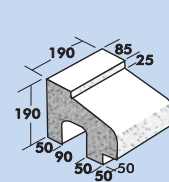

20.08
Sill (projecting)

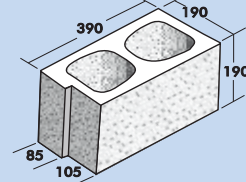

20.09
Rebate Whole

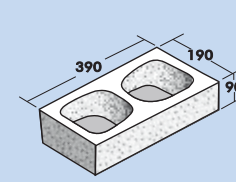

H20.04
Standard or Corner Half High

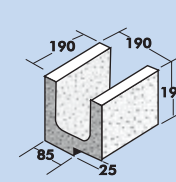

20.11
Rebated Lintel

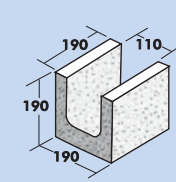

20.12
Lintel and Half-end Closer

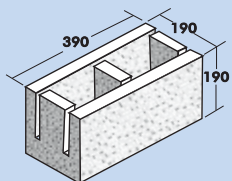

20.14
Knock-in Bond Beam

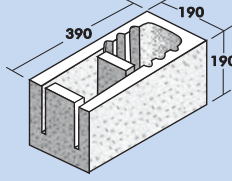

20.15
Corner Bond Beam

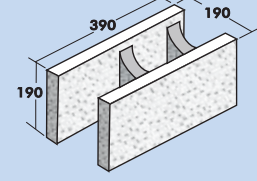

20.16
Open End Bond Beam Depressed Web

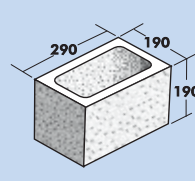

20.19
Three Quarter

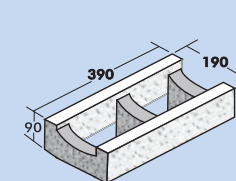

H20.14
Bond Beam Depressed Web

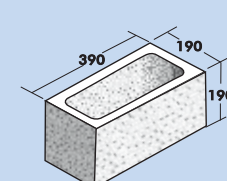

20.30
Standard 200mm Column

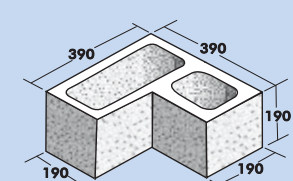

20.33
Pier

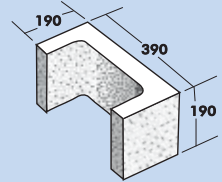

20.34
Pilaster 'C' Type

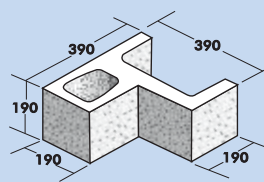

20.35
Pilaster 'H' Type

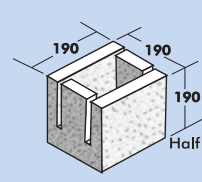

20.44
Knock-in Half Bond Beam

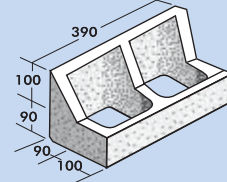

20.45
Header

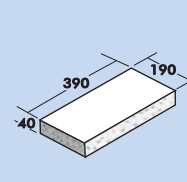

05.17
Capping

25 SERIES MASONRY BLOCKS

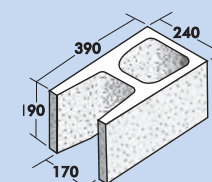

25.05
Open End and Plain End

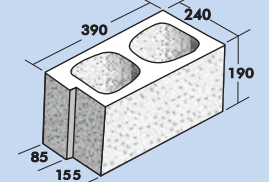

25.09
Rebate Whole

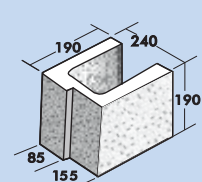

25.11
Rebate Lintel

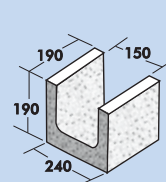

25.12
Lintel and
Half-end Closer

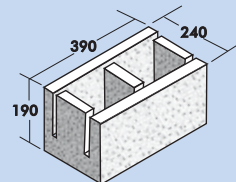

25.14
Knock-in Bond Beam

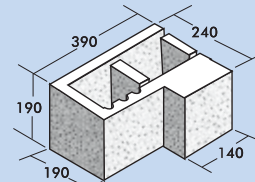

25.15
Left Hand Corner Bond Beam
(Right hand also available)

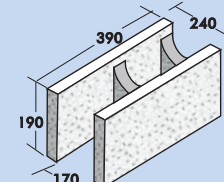

25.16
Open End Bond Beam
Depressed Web

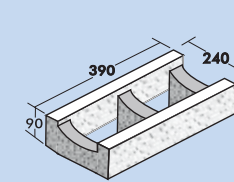

H25.14
Bond Beam
Depressed Web

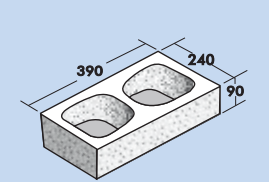

H25.04
Standard or Corner Half High